



D6.5mm NA0.15 Collimating Lens

Key Parameters

Diameter=6.5mm

NA=0.15

EFL=18.4mm / BL=17.1mm

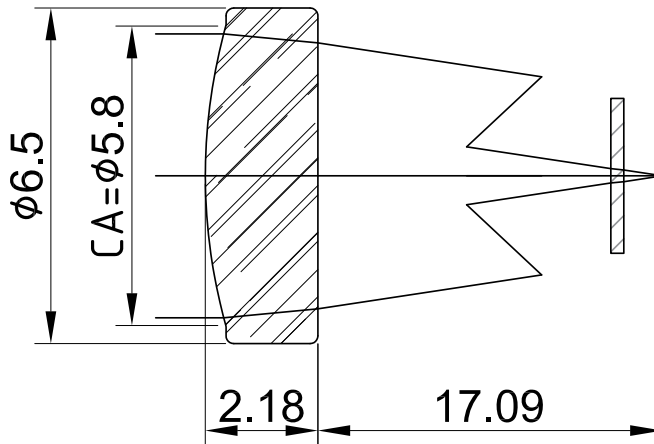

Application

Laser Sight Collimation/ Small Laser Pointer / Portable Laser Tag
Industry / Biochemical / Laser Sensing

Feature

- ◆ Aspherical Molding Glass Lens
 - For high temperature, low deformation, good reliability and abrasive resistance
- ◆ NA0.15 for divergent angle to 17°
- ◆ Small dimension size and short working distance for bigger divergent angle of laser diode

Introduction

Aspherical lenses are lenses with surfaces which are not a portion of sphere. Aspherical lenses are more superior in many applications than conventional lenses. One well designed aspherical lens can have the same or better performance than multiple spherical lenses. Therefore it reduces the number of lenses in one optical system and makes system lighter and more compact. Nowadays, by advanced high technology of production, aspherical lens has been successfully made in large quantity and meanwhile the cost is competitive against conventional high grade optical system. We provide various kinds of aspherical lenses. This document shows the specification of lens used in laser collimating. Besides the off-the-shelf lenses, customized lenses are also feasible based on customer's requirements.





Specifications	
Material	D-ZK3
Diameter(mm)	6.5±0.02
Design Wavelength(nm)	780
Clear Aperture(mm)	5.8
EFL(mm)	18.39±1%
BFL(mm)	17.09±1%
N.A.	0.15
Center Thickness(mm)	2.18±0.03
AR Coating(Optional)	400-700nm
R<1%	600-1050nm
Decentering	< 3 mins
Wavefront Aberration	RMS <0.08 λ
Surface Quality	40/20

Package

